



Laparoscope

Instructions for Use





Corporate Headquarters

Quest Medical Imaging B.V
Industrieweg 41
1775 PW Middenmeer
The Netherlands

Website: www.quest-mi.com

Customer Service and Technical Support

Email: info@quest-mi.com
Phone: +31-227-60-40-46
Fax: +31-227-60-41-85

Contact USA

Quest Medical Imaging Inc.
10000 Cedar Avenue
Suite 3-164
Cleveland, OH 44106 U.S.A.

Customer Service and Technical Support

Email: info@quest-mi.com
Phone: +1-33-07-52-65-96
Fax: +1-33-07-52-65-97

Document Identification

Document: QMI0024_IFU_EN
Revision: 3
Date of revision 12/05/2022

Copyright statement:

© 2022 Quest Medical Imaging B.V.

All rights reserved. No part of this document may be photocopied, reproduced, or translated in any way, without the prior written consent of Quest Medical Imaging B.V.

Every effort has been made to make the supplied product and its documentation as accurate as possible.

The information contained in this document is subject to change without notice.

Printed in The Netherlands.

Table of Contents

1	Health and Safety Compliance	3
1.1	Important Information	3
1.2	Indication for Use.....	3
1.3	Foreseeable misuse	4
1.3.1	Contraindications:	4
1.4	User Qualifications.....	4
1.5	Repair and Modification	4
1.6	Labels on Packaging	6
2	Safe application and preparation	7
2.1	Packaging and storage	7
2.2	Prior Use	7
2.3	Intraoperative Use	7
3	Assembly and Disassembly	9
3.1	Combinations	10
4	Cleaning/Disinfection	11
4.1	Safe treatment	11
4.2	After every use.....	11
4.3	Fiber Optic Cable cleaning/disinfection	12
4.3.1	Manual Cleaning/disinfection.....	12
4.3.2	Machine Cleaning/disinfection.....	12
4.4	Laparoscope machine cleaning/disinfection.....	12
4.5	Maintenance, checking	13
4.6	Packing	13
5	Sterilization	14
5.1	General Remarks.....	14
5.2	Sterilization method	14
5.2.1	Sterilization of Fiber Optic Cable	14
5.3	Storage	15
5.4	Information on validation	15
6	Accessories/spare parts	16
7	Standards/Directives	17
8	Disposal	18
8.1	General Remarks.....	18
8.1.1	Wet Disposal.....	18
8.1.2	Dry Disposal	18
9	Technical Specifications	19
10	Manufacturer declaration	20

1 Health and Safety Compliance

1.1 Important Information



WARNING: Read Before Use



This instruction manual contains essential information on using the Quest Spectrum® Laparoscopes safely and effectively. Before use, thoroughly review this manual and use the system as instructed.

Keep this manual in a safe, accessible location. Questions or comments about any information in this manual should be sent to Quest Medical Imaging B.V.

The following signal words serve to distinguish between warning notes according to the type of danger:



WARNING: indicates risks to the safety of the patient or user. Failure to follow warnings may result in injury to the patient or user.



CAUTION: indicates risks to the equipment. Failure to follow cautions may result in product damage.



Note: provides special information to clarify instructions or present additional useful information.

1.2 Indication for Use

For ART-LAP-0008, ART-LAP-0009

During the examination, diagnosis and/or (in combination with endoscopic accessories) treatment, laparoscopes serve exclusively to visualize following fields of application:

- Laparoscopy
- Thoracoscopy
- Transanal procedures
- Transvaginal procedures

For ART-LAP-0008S, ART-LAP-0009S

During the examination, diagnosis and/or (in combination with endoscopic accessories) treatment, laparoscopes serve exclusively to visualize following fields of application:

- Laparoscopy
- Thoracoscopy
- Axillary section / identification of lymph nodes
- Parathyroid



WARNING: The Quest Spectrum® Laparoscope should be used according to its approved Indication for Use.

1.3 Foreseeable misuse



WARNING: Do not use Laparoscopes for endoscopic applications different than stated in the Indication for Use.



WARNING: Connect Laparoscopes exclusively to BF devices (body floated devices).



WARNING: Do not use Laparoscope in combination with the Quest Spectrum® 3 Mechanical Arm

1.3.1 Contraindications:

There are no absolute contraindications against laparoscopy, thoracoscopy, transanal and transvaginal procedures which would not equally apply to open surgery in general. Known relative contraindications against laparoscopy include:

- Previous surgery/severe adhesions
- Pulmonary diseases
- Heart diseases
- Pregnancy

Do not use the device for procedures in which it would regularly come in physical contact with the beating heart.

The operating physician must judge according to professional standards whether a specific procedure is appropriate or not.

1.4 User Qualifications

This manual is addressed exclusively to qualified personnel (licensed physician, medical assistants supervised by a licensed physician) in an adequate medical environment. The Quest Spectrum® Laparoscope is to be used exclusively by qualified personnel to carry out clinical applications.



WARNING: This manual does not explain or discuss clinical procedures. The qualified personnel are responsible for correct execution of clinical procedures.

1.5 Repair and Modification



WARNING: Do not disassemble, modify, or attempt to repair the Quest Spectrum® Laparoscopes. This can result in patient or user injury and/or instrument damage.

- ❖ Let exclusively the respective dealer or a repair facility authorized by Quest Medical Imaging B.V carry out repair works.
- ❖ Use exclusively original spare parts for repair works.

Before sending it back:

- ❖ Clean, disinfect and sterilize the light guide cable and laparoscope thoroughly prior to returning for repair.

- ❖ **Return the part in its original packaging. If this is not possible, package the part to secure it for transport.**
- ❖ **Quest Medical Imaging is not liable for damage resulting from improper shipping.**













Note:

The guarantee and warranty claims expire if repair works are not carried out by repair facilities authorized by Quest Medical Imaging B.V.

1.6 Labels on Packaging

Table 1: Labels on Packaging

Observe Operating Instructions	
Date of Manufacture	
Manufacturer	
Batch code	
Serial number	
Article number	
Non-sterile	
Keep away from sunlight	
Keep dry	
Indicates the device is a medical device	
Unique Device Identifier	

2 Safe application and preparation

2.1 Packaging and storage



WARNING: The laparoscope is not sterilely packed.

- ❖ Prior to the first sterilization, clean the laparoscope thoroughly (see chapter 4 Cleaning/ Disinfection).
- ❖ After every use, clean, disinfect and sterilize the laparoscope (see chapter 4 Cleaning/ Disinfection).
- ❖ Keep the new or unused laparoscope in a dry, clean, and safe place at room temperature.
- ❖ Store and pack laparoscopes individually in a dry place at room temperature.



CAUTION: Do not bend the laparoscope.



Note: To prevent damages on the working end: Insert the laparoscope carefully through a trocar.

2.2 Prior Use



Note: After every cleaning/disinfection and prior to every use, check the laparoscope for: cleanliness, function, and damages, e.g., insulation, loose, bent, broken, chapped, rough, worn, broken off parts etc. If necessary, dispose of Laparoscopes correctly (see chapter 8).



WARNING: Do not use a damaged or defective laparoscope. Contact Quest Medical Imaging B.V.

2.3 Intraoperative Use



WARNING: It is possible that light with a high radiation energy emerges from the viewing window and raises the temperature of the tissue.

- ❖ Make sure that the surface temperature of the body does not exceed 41 °C.
- ❖ During longer applications, let the body cool down if necessary.
- ❖ Only use light sources from Quest Medical Imaging B.V.



WARNING: In case of suspected or diagnosed Creutzfeldt-Jacob syndrome, Quest Medical Imaging B.V recommends not to reuse the laparoscope but to dispose of it.

Immediately take measures to prevent the infection of other patients, users or third parties.

Observe country-specific laws and specifications.



CAUTION: To maintain the optical quality, make sure that the laparoscopes are not exposed to gamma rays.



Note: Check image quality (clear and free of distortion) and light transmission through the glass fibers.

- ❖ Hold the light guide connector against non-glare light. Should the glass fibers appear as black spots on the distal end (broken glass fibers), it is possible that the light output is insufficient.

3 Assembly and Disassembly

Figure 1 shows the construction of the Quest Spectrum® Laparoscope. The Eyepiece can be only connected to the Quest Spectrum® Camera. Table 2 provides an overview of all laparoscopes provided by Quest Medical Imaging B.V and Table 3 provides an overview of all accessories.

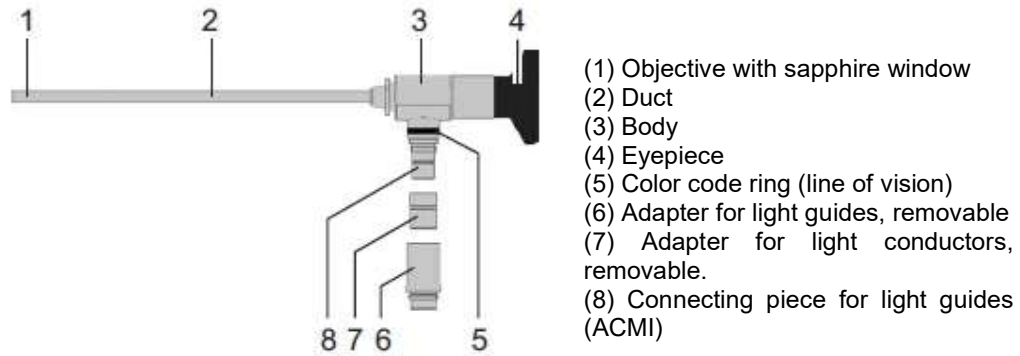

Figure 1: Construction of the Laparoscope



Note: Only the light guide connector can be dissembled from the Laparoscope.

Table 2: overview of all laparoscopes provided by Quest Medical Imaging B.V.

Article Number	Line of vision	Color Code	Field of View	Working Length
ART-LAP-0008	30°	Red	70°	290 mm
ART-LAP-0008S	30°	Red	70°	150 mm
ART-LAP-0009	0°	Green	70°	290 mm
ART-LAP-0009S	0°	Green	70°	150 mm

Table 3: accessories of the Laparoscope

Article Number	Name	Use
ART-OP-0007	Optical fiber cable	Light Guide from Light Engine to Laparoscope

For a safe assembly:

- ❖ Always hold the laparoscope on the body or the eyepiece.
- ❖ Make sure that the adapters of the light- conducting cables comply with the adapters of the laparoscope (see Figure 1).
- ❖ Make sure that glass surfaces do not interact with other instruments.



Figure 2: Connecting the laparoscope to the camera

When assembling, make sure that the three pins on the ring laparoscope fit into the camera (Figure 2).

3.1 Combinations



WARNING: Danger to life due to high tensions and currents!

Make sure that the leakage currents of the patient are minimized for combinations:

- ❖ Connect the Laparoscopes only to devices and accessories authorized by Quest Medical Imaging B.V.
- ❖ Connect Laparoscopes exclusively to BF devices (body floated devices).



WARNING: Do not use Laparoscope in combination with the Quest Spectrum® 3 Mechanical Arm



Note: Contact Quest Medical Imaging B.V if you want to connect devices not provided by Quest Medical Imaging B.V.

4 Cleaning/Disinfection

4.1 Safe treatment

Make sure that laparoscopes and accessories are cleaned and sterilized exclusively by trained and qualified personnel.

- ❖ Clean and sterilize laparoscopes before first use. Remove protective transport sheaths.
- ❖ Clean and sterilize laparoscope before every use.
- ❖ Exclusively treat laparoscopes and accessories suitable for:
 - immersion in cleaning agent
 - vapor sterilization
- ❖ Use exclusively cleaning agents for complete protein dissolution.



WARNING: Do not exceed maximum number of treatments (see manual of respective product).



WARNING: Do not use laparoscopes or accessories once their product lives are expired (see manual of respective product).



WARNING: Treat laparoscopes and accessories before the first and after every use.



WARNING: Make sure that laparoscopes and accessories do not touch during cleaning.



WARNING: Prevent any fixation of proteins before and during treatment.



CAUTION: Do not apply strong manual pressure.



CAUTION: Do not use abrasive cleaning agents or metal brushes.



CAUTION: Do not use plastic sheaths for treatment.



CAUTION: Do not clean laparoscopes in an ultrasonic bath.



CAUTION: Do not gamma-sterilize laparoscopes.

4.2 After every use

After every use treat contaminated laparoscopes and accessories as soon as possible.

1. Disassemble detachable laparoscopes and accessories.
2. Remove sealing caps.
3. Soak encrusted laparoscopes in 3 % H₂O₂ for 5 minutes before cleaning and disinfection.
4. Use fully desalinated water. Clean manually or in a machine. Observe manufacturer's indications (e.g., dosing).
5. Always machine-clean after contact with:
 - ❖ blood
 - ❖ wounds
 - ❖ interior tissue
 - ❖ organs



CAUTION: In case of contact with a corrosive substance, clean with water immediately.

4.3 Fiber Optic Cable cleaning/disinfection



CAUTION: Clean Optic Fiber Cable separate from laparoscopes, according to the instructions in this section.

4.3.1 Manual Cleaning/disinfection

To clean the fiber optic cable manually, perform the following steps:

1. Fiber optic cables require similar care to that taken for any precision optical component. After each use, and prior to disinfection or sterilization, the fiber optic cable should be washed and cleaned of all debris.
2. Scrub the fiber optic cable with a soft brush using a neutral pH enzymatic cleaner or mild detergent until all visible contamination has been removed, paying particular attention to any crevices or seams. Always avoid any harsh materials or detergents that can scratch or in any way damage the optical surfaces on each end of the fiber optic cable. To avoid health risks from aerosol contamination, brush the device only when it is submerged in liquid.
3. Chemical disinfection is recommended for use on this device for each processing. Only use chemical disinfectants that are approved for use on optic cables. Follow the parameters suggested by the manufacturer of the disinfectant.

4.3.2 Machine Cleaning/disinfection

To clean the fiber with a machine, perform the following steps:

1. The device is approved for automated cleaning in hospital grade washer using the full cycle.
2. Use the parameters recommended by the washer manufacturer and detergent manufacturer for this type of device.
3. Fiber optic cables are not intended to be cleaned using alkaline cleaners (pH above 10). They will be damaged by alkaline cleaners and must be cleaned with enzymatic cleaners per the instructions.
4. Chemical disinfection is recommended for use on this device for each processing. Only use chemical disinfectants that are approved for use on optic cables. Follow the parameters suggested by the manufacturer of the disinfectant.

4.4 Laparoscope machine cleaning/disinfection



Note: Quest Medical Imaging B.V recommends machine cleaning for laparoscopes and accessories.

To clean the laparoscopes with a machine, perform the following steps:

1. Carry out thermal disinfection in a machine. Observe national requirements regarding A0 value (see ISO 15883).
2. Clean laparoscopes and accessories exclusively in instrument washers, and with suitable methods.
3. Observe indications of ultrasound cleaner, washers, and cleaning agent manufacturers.

4. Make sure that manufactures of ultrasound cleaners, washers, and cleaning agents recommend their methods for laparoscopes and accessories.
5. For machine cleaning, put laparoscopes and accessories on suitable screen baskets suitable for cleaning (avoid "cleaning shadows").
6. Make sure that laparoscopes and accessories are properly secured in the holders.
7. Connect rinsing or working channels of laparoscopes and accessories to rinsing connectors of washer.
8. Use a cleaning agent with a medium pH value (5 - 11).
9. Soak laparoscopes and accessories in enzymatic cleaning agent for 15 minutes at most.
10. Use thermically neutral methods in the pH-neutral range (e.g., enzymatic cleaning agents).
11. Select cleaning cycle depending on material (e.g., stainless instrument steel, aluminum) of laparoscopes and accessories to be cleaned. Observe indications of device manufacturer.
12. Pre-rinse laparoscopes twice.
13. Clean laparoscopes at 40 °C - 60 °C.
14. Disinfect at 80 °C - 95 °C.
15. Dry at 50 °C.
16. Observe sufficient drying time.
17. Make sure that there is no residue on the glass fiber surface. This can possibly impair light transmission through burning in when exposed to a light source.
18. Take laparoscopes and accessories out of washer immediately when cleaning cycle is finished.
19. Allow laparoscopes and accessories to cool down to room temperature (23 ± 2 °C).

4.5 Maintenance, checking

- ❖ Allow laparoscopes and accessories to cool down to room temperature.
- ❖ After every cleaning and disinfection, check laparoscopes and accessories for protein residue and dirt. Clean contaminated or dirty laparoscopes and accessories again.
- ❖ Lightly grease movable parts (e.g., hinges and ends) with serializable, vapor-permeable protective oil.
- ❖ Use exclusively bio-compatible, paraffin oil-based lubricants (exception: latex and rubber).
- ❖ Assemble detachable laparoscopes and accessories.
- ❖ After every cleaning/disinfection, check laparoscopes and accessories for: cleanliness, proper functioning, and damage, e.g., loose, bent broken, cracked, worn, missing parts etc.
- ❖ Reject and replace damaged, defective, stained, or cloudy laparoscopes and accessories.
- ❖ Laparoscopes and accessories are maintenance-free.

4.6 Packing

- ❖ Always store and package laparoscopes individually.
- ❖ Store laparoscopes in original packaging, or in a suitably sized sterilization container.
- ❖ Store laparoscopes with small diameters (3.0 mm and less) in the protective transport and storage sheaths available at Quest Medical Imaging B.V.

5 Sterilization

5.1 General Remarks



Note:

It is possible for sterilization methods not listed in this manual to be compatible with Quest Medical Imaging B.V laparoscopes and accessories.

When using methods other than those listed in this manual, the user is responsible for the sterility.

- ❖ Use exclusively suitable methods for sterilizing laparoscopes and accessories (see chapter 5.2 Sterilization method).
- ❖ Make sure that enough sterile laparoscopes and accessories is available.

Observe the following when sterilizing:

1. Clean laparoscopes thoroughly before sterilizing (see chapter 4 Cleaning/disinfection).
2. Make sure that the entire surface is exposed to the sterilization medium.
3. Avoid any contact with metal surfaces.
4. Make sure that laparoscopes are properly secured in the holders.
5. Do not sterilize laparoscopes still in their protective transport sheaths.
6. Sterilize laparoscopes individually and suitably packaged.

5.2 Sterilization method

- ❖ Sterilize laparoscopes according to generally accepted hospital method.
- ❖ Observe manufacturer's indications for auxiliaries.
- ❖ Make sure that products are packaged according to ISO 11607 and EN 868 for sterilization.
- ❖ Carry out sterilization according to EN 13060/EN ISO 17665-1.
- ❖ Observe applicable country-specific requirements.

Table 4 Validated Sterilization method.

Parameters	134 °C / 273°F Double fore-vacuum	132 °C / 270°F Double fore-vacuum
Sterilization time	3 – 20 min	4 – 20 min
Packaging	Metal sterilization containers, paper laminate sterilization bags, Type Steriking	Metal sterilization containers, paper laminate sterilization bags, Type Steriking



Note:

Exclusively vapor-sterilize laparoscopes marked autoclavable.



CAUTION:

Do not accelerate cooling of laparoscopes and accessories. This will cause damage and reduce the product life.

- ❖ Allow laparoscopes and accessories to cool down to room temperature (23 ± 2 °C).
- ❖ Open packages after cooling.

5.2.1 Sterilization of Fiber Optic Cable

- ❖ For best sterilization performance and longest device life it is best to sterilize the cable separately. Other items in the sterilization tray may result in incomplete sterilization or damage to the fiber optic cable.
- ❖ Place the fiber optic cable in a tray approved for use with this type of device.
- ❖ Do not place the cable in a Tyvek® pouch for Steam or STERRAD® systems as the pouch may melt to the fiber optic cable and cause permanent damage to the device.
- ❖ After sterilization allow the cable to cool slowly to room temperature. Do not immerse or rinse with cold liquid as fiber breakage will occur and cause permanent damage to the device.
- ❖ The fiber optic cable is validated for steam sterilization using the following parameters:

Table 5: Validated Sterilization method for Fiber Optic Cable.

Steam Sterilization Parameters				
Method	Cycle	Exposure Temperature	Exposure Time	Dry Time
Steam	Pre-vacuum	134°C (273°F)	3 Minutes	20 Minutes

5.3 Storage

After sterilizing, store laparoscopes in a dry, dust-free, and well-aired place (free of corrosive vapors).

5.4 Information on validation

In accordance with ISO17664, the cleaning and sterilization methods described in this section are validated on the device.

The following materials and machines were used for the validation:

- ❖ Precleaning agent: Neodisher Medizym 0.5%
- ❖ Cleaning agent: Neodisher Medizym 0.5%
- ❖ Washer-disinfector unit: Miele PG8535
- ❖ Steam Autoclave: Lautenschläger ZentraCert
- ❖ Sterilizing agent: humid heat

6 Accessories/spare parts

Our catalogs contain information about accessories and spare parts.

7 Standards/Directives

All laparoscopes are manufactured in accordance with the following directives:

- Medical device regulation 2017/745
- Medical device directive 93/42 EWG last changed by 2007/47/EG
- EN ISO 13485
- Series of standards IEC 60601
- Series of standards ISO 8600
- FDA regulations (FDA Quality System Regulation 21 CFR Part 820) other product and material-specific standards and regulations

8 Disposal

8.1 General Remarks

For the disposal, mind the following:

- ❖ Dispose of the packaging and used parts in accordance with the country-specific regulations.
- ❖ Protect the device from access by unauthorized persons.

8.1.1 Wet Disposal

- ❖ Use cleaning-active disinfectants.
- ❖ Completely immerse endoscopes and accessories in a non-corrosive, non-fixing disinfection bath that is changed daily.
- ❖ Leave endoscopes and accessories in disinfection bath for a maximum of 8 hours.
- ❖ Before machine cleaning and disinfection, rinse endoscopes and accessories thoroughly under clear running water.

8.1.2 Dry Disposal

- ❖ Machine-clean endoscopes and accessories.

For the disposal, mind the following:

- ❖ Dispose of the packaging and used parts in accordance with the country-specific regulations.
- ❖ Protect the device from access by unauthorized persons.

9 Technical Specifications

Table 6: Technical specifications

Quest Spectrum® Laparoscope			
Length	290mm working length / 385mm total length		
Length short	150mm working length / 245mm total length		
Ambient operating temperature	10 – 40 °C		
Ambient operating humidity	20%-70%		
Laparoscope 30 degrees	30° / 70° (DOV/FOV)		
Laparoscope 0 degrees	0° / 70° (DOV/FOV)		
Length	290mm working length / 385mm total length		
Length short	150mm working length / 245mm total length		
Diameter	10mm		
Working distance	10mm – 150mm		
Life Cycle	200 cycles		
Attributes / Accessories	Not applicable		
Autoclavable	Parameters	134 °C / 273°F Double fore-vacuum	132 °C / 270°F Double fore-vacuum
	Sterilization time	3 – 20 min	4 – 20 min
	Packaging	Metal sterilization containers, paper laminate sterilization bags, Type Steriking	Metal sterilization containers, paper laminate sterilization bags, Type Steriking
Dimensions	Article code	Identifier	Dimensions
	ART-LAP-0008	0 degrees	385 x 35 x 45 mm
	ART-LAP-0008S	30 degrees short	290 x 35 x 45 mm
	ART-LAP-0009	0 degrees	385 x 35 x 45 mm
	ART-LAP-0009S	0 degrees short	290 x 35 x 45 mm
Weight	Article code	Identifier	Weight
	ART-LAP-0008	30 degrees	180.54 g
	ART-LAP-0008S	30 degrees short	216.70 g
	ART-LAP-0009	0 degrees	180.91 g
	ART-LAP-0009S	0 degrees short	150.83 g

10 Manufacturer declaration

Declarations of Conformity

Manufacturer: Quest Medical Imaging B.V.
Industrieweg 41
1775 PW Middenmeer
the Netherlands

We declare under our sole responsibility that the Quest Spectrum® Laparoscope complies with the following directive:

Regulation 2017/745 for medical devices



The individual components of your Quest Spectrum® Laparoscope bear the CE mark. Quest Medical Imaging B.V. herewith declares that:

- (a) We have verified the mutual compatibility of the devices of the Quest Spectrum® Laparoscope in accordance with the manufacturers' instructions and have carried out his operations in accordance with these instructions;
- (b) We have packaged the Quest Spectrum® Laparoscope and supplied relevant information to users incorporating relevant instructions from the manufacturers; and
- (c) We have subjected the whole activity to appropriate methods of internal control and inspection.